

Lidco 260 System 3 Panel Horizontal Slider Fixed to Capral 400 Series Frame - 6 and 8mm Glass



Head, Sill and Jamb

Scale 1:2

HEAD DETAIL

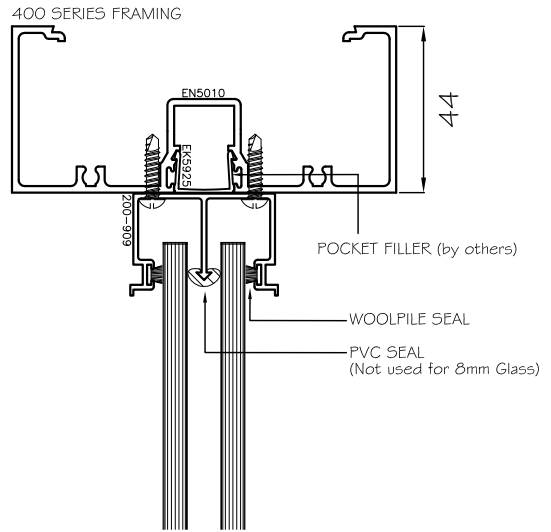

TYPICAL ELEVATION

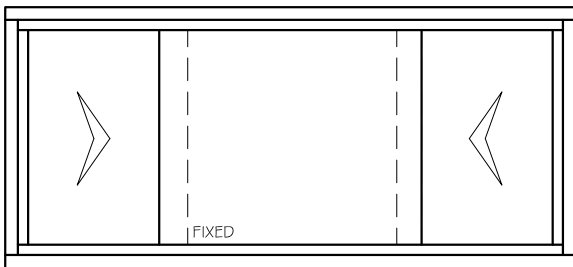

NOTE: THIS WINDOW HAS NO WATER RATING AND IS ONLY SUITABLE WHERE NON-WEATHERPROOF SASHLESS SLIDING PANELS ARE REQUIRED.

Please see the latest update for further development on Austview Sashless water rated horizontal windows.

OUTSIDE

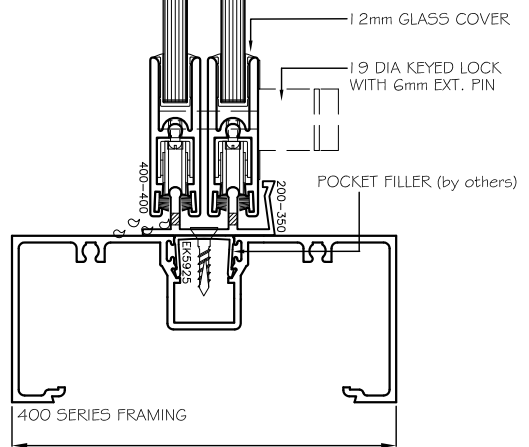

SILL DETAIL

JAMB DETAIL

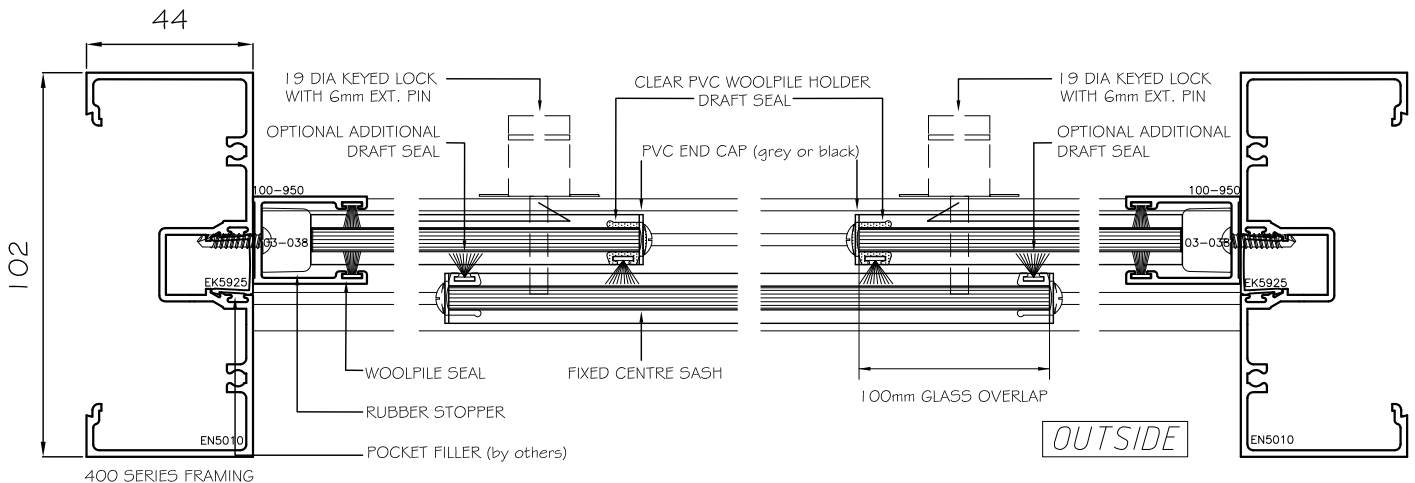

OUTSIDE